

Part Number	Chip		Lens Color	V <sub>F</sub> I <sub>F</sub> =20mA			Reverse Current TYP.	Peak Forward Current MAX.	Power Dissipation TYP.	I <sub>v</sub> (mcd) I <sub>F</sub> =20mA			View Angle
	Emitted Color	λ P (nm)		MIX	TYP	MAX				MIX	TYP	MAX	
5AR2PD	● RED	680	D.	2.0	2.2	2.5	10uA	200mA	100mW	8	12	-----	70
5AR2HD	● RED	640	D.	1.7	1.9	2.3	10uA	200mA	100mW	60	80	-----	70
5AR2SD	● RED	640	D.	1.7	1.9	2.3	10uA	200mA	100mW	-----	300	-----	70
5AR2UD	● RED	640	D.	1.7	1.9	2.3	10uA	200mA	100mW	-----	600	-----	70
5AYG2HD	● YELLOW GREEN	570	D.	2.0	2.3	2.5	10uA	200mA	100mW	60	80	-----	70
5AY2HD	● YELLOW	590	D.	2.0	2.1	2.5	10uA	200mA	100mW	50	80	-----	70
5AO2HD	● ORANGE	680	D.	2.0	2.2	2.5	10uA	200mA	100mW	80	150	-----	70
5AR2PT	● RED	600	T.	1.9	2.1	2.4	10uA	200mA	100mW	200	350	-----	70
5AR2HT	● RED	640	T.	1.7	1.9	2.3	10uA	200mA	100mW	70	100	-----	30
5AYG2HT	● YELLOW GREEN	570	T.	2.0	2.3	2.5	10uA	200mA	100mW	200	250	-----	30
5AY2HT	● YELLOW	590	T.	2.0	2.1	2.5	10uA	200mA	100mW	250	350	-----	30
5AO2HT	● ORANGE	600	T.	1.9	2.1	2.4	10uA	200mA	100mW	300	700	-----	30
5AP2HC	● PURPLE	400	W.C.	3.0	3.5	3.8	10uA	200mA	100mW	150	300	-----	30
5AR2SC	● RED	640	W.C.	1.7	1.9	2.3	10uA	200mA	100mW	800	1000	-----	20
5AYG2SC	● YELLOW GREEN	570	W.C.	2.0	2.3	2.5	10uA	200mA	100mW	200	300	-----	
5AY2SC	● YELLOW	590	W.C.	2.0	2.1	2.5	10uA	200mA	100mW	2000	2500	-----	
5AO2SC	● ORANGE	600	W.C.	1.9	2.1	2.4	10uA	200mA	100mW	1000	2000	-----	
5AW2SC	● WHITE	-----	W.C.	2.8	3.2	3.6	10uA	200mA	100mW	2000	3000	-----	
5AB2SC	● BLUE	470	W.C.	2.8	3.2	3.6	10uA	200mA	100mW	1500	2000	-----	
5AP2SC	● PURPLE	410	W.C.	3.0	3.5	3.8	10uA	200mA	100mW	1000	1500	-----	
5AR2UC	● RED	625	W.C.	1.7	1.9	2.3	10uA	200mA	100mW	2000	3000	-----	20
5APG2UC	● GREEN	525	W.C.	2.8	3.2	3.6	10uA	200mA	100mW	5000	7000	-----	
5AW2UC	● WHITE	-----	W.C.	2.8	3.2	3.6	10uA	200mA	100mW	4000	5000	-----	
5AY2UC	● YELLOW	590	W.C.	2.0	2.1	2.5	10uA	200mA	100mW	3000	4000	-----	
5AB2UC	● BLUE	470	W.C.	2.8	3.2	3.6	10uA	200mA	100mW	2000	3000	-----	
5AO2UC	● ORANGE	600	W.C.	1.9	2.1	2.4	10uA	200mA	100mW	2000	2500	-----	

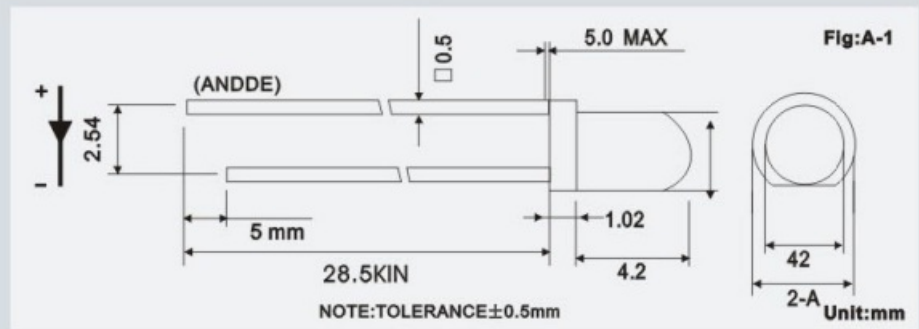

Part Number	Chip		Lens Color	V <sub>F</sub> I <sub>F</sub> =20mA			Reverse Current TYP.	Peak Forward Current MAX.	Power Dissipation TYP.	I <sub>v</sub> (mcd) I <sub>F</sub> =20mA			View Angle
	Emitted Color	λ P (nm)		MIX	TYP	MAX				MIX	TYP	MAX	
5AR4PD	● RED	680	D.	2.0	2.2	2.5	10uA	200mA	100mW	8	12	.....	70
5AR4HD	● RED	640	D.	1.7	1.9	2.3	10uA	200mA	100mW	60	80	.....	70
5AR4SD	● RED	640	D.	1.7	1.9	2.3	10uA	200mA	100mW	.....	300	.....	70
5AR4UD	● RED	640	D.	1.7	1.9	2.3	10uA	200mA	100mW	.....	600	.....	70
5AYG4HD	● YELLOW GREEN	570	D.	2.0	2.3	2.5	10uA	200mA	100mW	60	80	.....	70
5AY4HD	● YELLOW	590	D.	2.0	2.1	2.5	10uA	200mA	100mW	50	80	.....	70
5AO4HD	● ORANGE	680	D.	2.0	2.2	2.5	10uA	200mA	100mW	80	150	.....	70
5AR4PT	● RED	600	T.	1.9	2.1	2.4	10uA	200mA	100mW	70	100	.....	70
5AR4HT	● RED	640	T.	1.7	1.9	2.3	10uA	200mA	100mW	200	350	.....	30
5AYG4HT	● YELLOW GREEN	570	T.	2.0	2.3	2.5	10uA	200mA	100mW	200	250	.....	30
5AY4HT	● YELLOW	590	T.	2.0	2.1	2.5	10uA	200mA	100mW	250	350	.....	30
5AO4HT	● ORANGE	600	T.	1.9	2.1	2.4	10uA	200mA	100mW	300	700	.....	30
5AP4HC	● PURPLE	400	W.C.	3.0	3.5	3.8	10uA	200mA	100mW	150	300	.....	30
5AR4SC	● RED	640	W.C.	1.7	1.9	2.3	10uA	200mA	100mW	800	1000	.....	20
5AYG4SC	● YELLOW GREEN	570	W.C.	2.0	2.3	2.5	10uA	200mA	100mW	200	300	.....	
5AY4SC	● YELLOW	590	W.C.	2.0	2.1	2.5	10uA	200mA	100mW	2000	2500	.....	
5AO4SC	● ORANGE	600	W.C.	1.9	2.1	2.4	10uA	200mA	100mW	1000	2000	.....	
5AW4SC	● WHITE	.....	W.C.	2.8	3.2	3.6	10uA	200mA	100mW	2000	3000	.....	
5AB4SC	● BLUE	470	W.C.	2.8	3.2	3.6	10uA	200mA	100mW	1500	2000	.....	
5AP4SC	● PURPLE	410	W.C.	3.0	3.5	3.8	10uA	200mA	100mW	1000	1500	.....	
5AR4UC	● RED	625	W.C.	1.7	1.9	2.3	10uA	200mA	100mW	2000	3000	.....	
5APG4UC	● GREEN	525	W.C.	2.8	3.2	3.6	10uA	200mA	100mW	5000	7000	.....	20
5AW4UC	● WHITE	.....	W.C.	2.8	3.2	3.6	10uA	200mA	100mW	4000	5000	.....	
5AY4UC	● YELLOW	590	W.C.	2.0	2.1	2.5	10uA	200mA	100mW	3000	4000	.....	
5AB4UC	● BLUE	470	W.C.	2.8	3.2	3.6	10uA	200mA	100mW	2000	3000	.....	
5AO4UC	● ORANGE	600	W.C.	1.9	2.1	2.4	10uA	200mA	100mW	2000	2500	.....	

**PACKAGE DIMENSIONS**

NOTE:TOLERANCE±0.5mm UNIT:mm

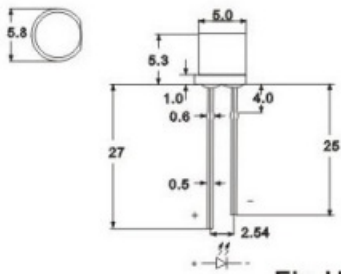

**Fig.H**

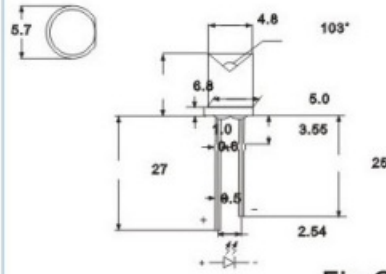

**Fig.G**

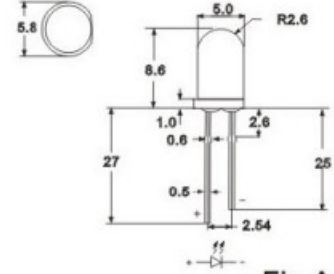

**Fig.A-8**

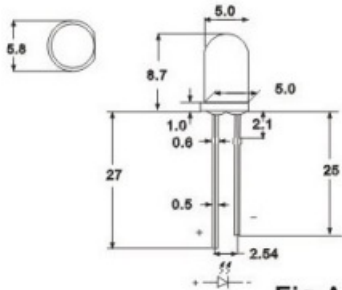

**Fig.A-9**

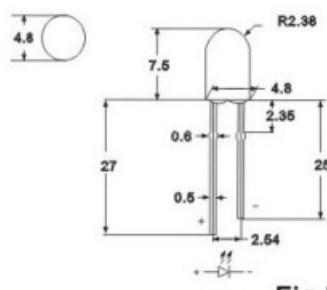

**Fig.B-4**

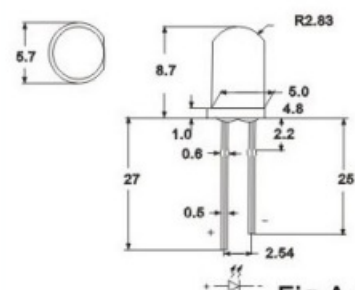

**Fig.A-10**

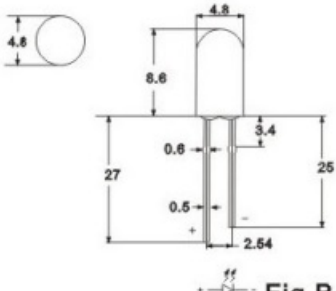

**Fig.B-5**

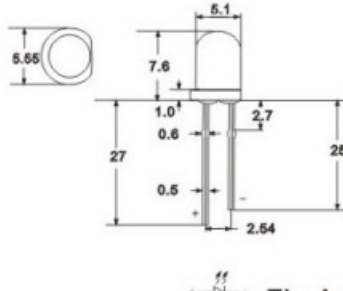

**Fig.A-11**

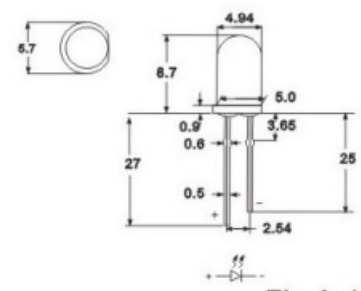

**Fig.A-12**

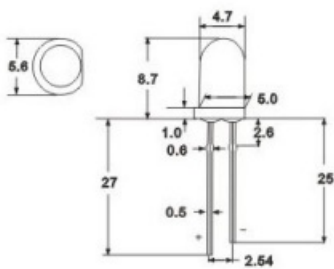

**Fig.A-13**

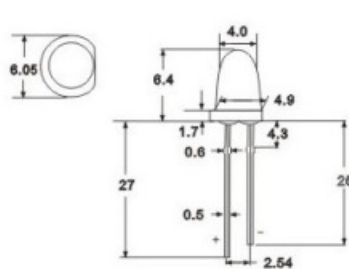

**Fig.D-1**

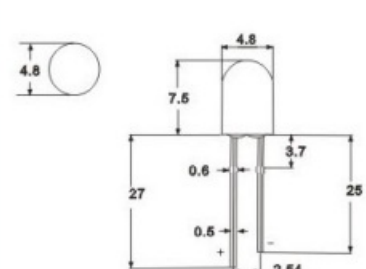

**Fig.B-6**