

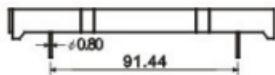

PACKAGE DIMENSION

CPM46058

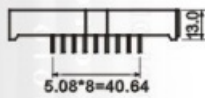
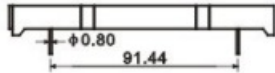
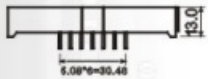
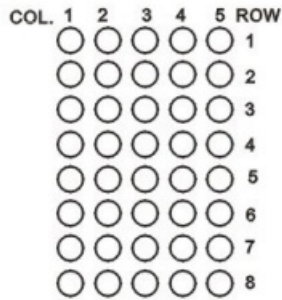
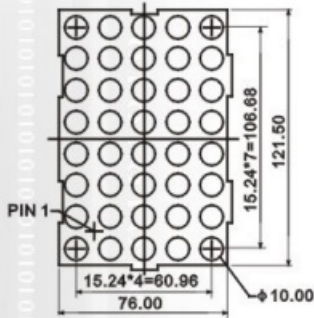

INTERNAL CIRCUIT DIAGRAM

PCB:M46058A/B



PCB:M46058A/B

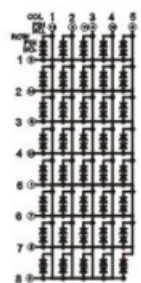

PCB:M46058A/BEG

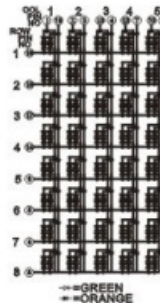

PCB:M46058A/BEG

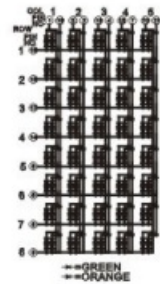

PACKAGE DIMENSION

CPLBS1006A

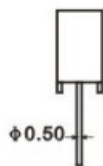
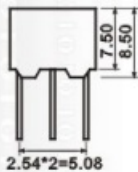
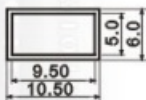

INTERNAL CIRCUIT DIAGRAM

PCB:LBS1006A-2A/BEG

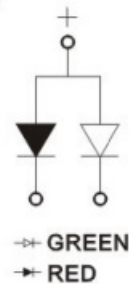

PACKAGE DIMENSION

CPLBS1006A

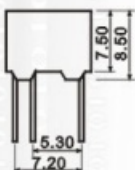
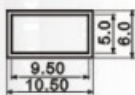

INTERNAL CIRCUIT DIAGRAM

PCB:LBS1006A-2C/DEG

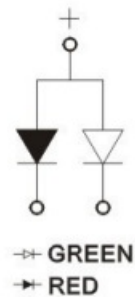

**PACKAGE DIMENSION**

**INTERNAL CIRCUIT DIAGRAM**

**CPLBS1006A**

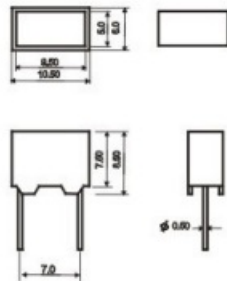

**PCB:LBS1006A-2A**

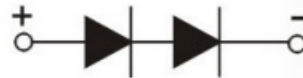

**PACKAGE DIMENSION**

**INTERNAL CIRCUIT DIAGRAM**

**CPLBS1207A**

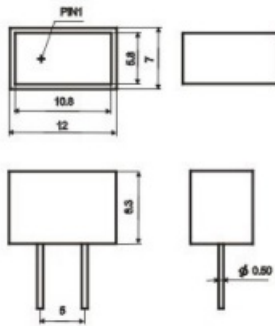

**PCB:LBS1207A-2A**



**PACKAGE DIMENSION**

**INTERNAL CIRCUIT DIAGRAM**

**CPLBS1708A**

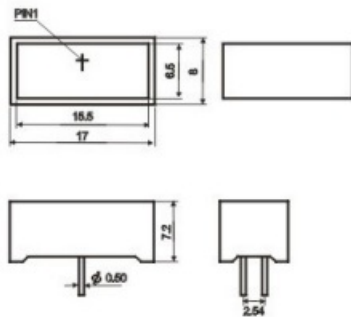

**PCB:LBS1708A-3A/B**

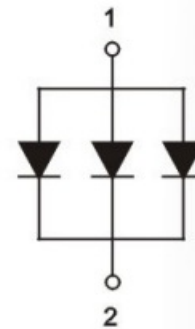

**PACKAGE DIMENSION**

**INTERNAL CIRCUIT DIAGRAM**

**CPLBS1711A**

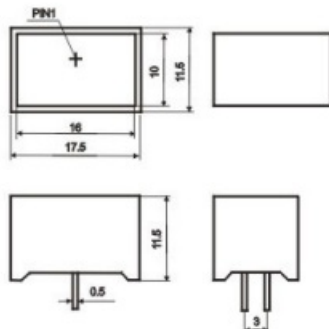

**PCB:LBS1711A-3A/B**

